

Article number: 604144064050

Description: Timing belt pulley with hub
HTD 64 8M 50

Measures

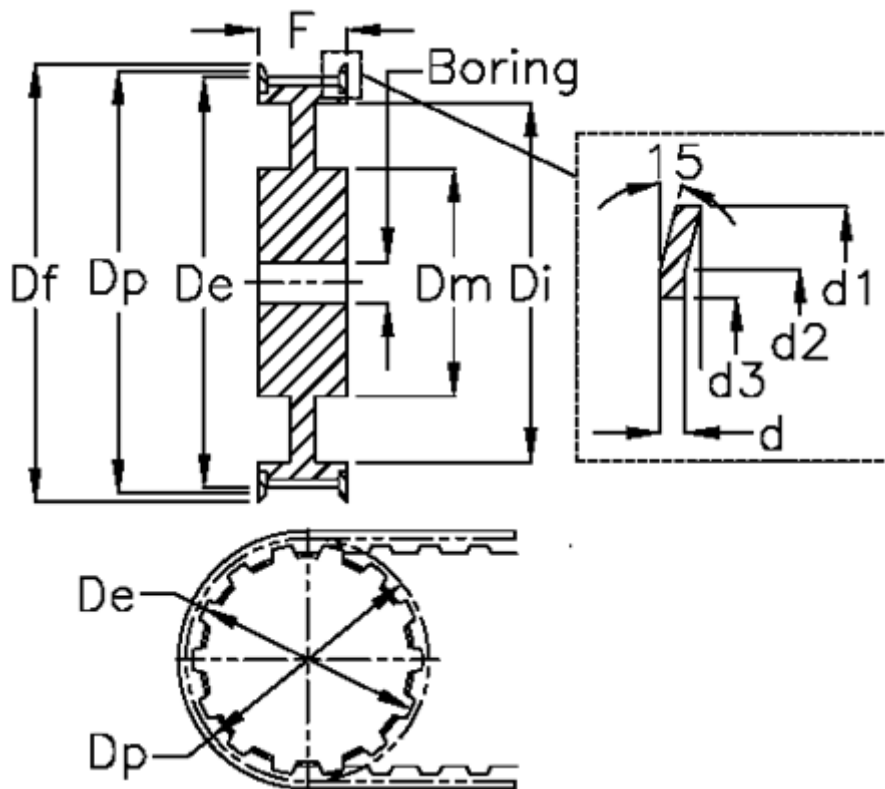

Bore = 18	Dm = 100	Width = 50
d = 1.5	Dp = 162.97	
d1 = 168	F = 137	
d2 = 161	Flange type = F52	
d3 = 148	L = 60	
De = 161.6	Tooth number = 64	
Df = 168	Type = 8M	
Di = 60	Weight = 5.6	